

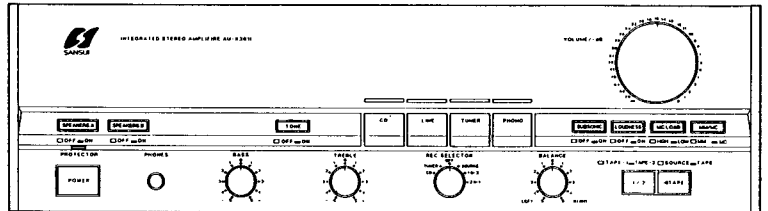

SERVICE MANUAL

AU-X201i AU-X301i INTEGRATED STEREO AMPLIFIER



CAUTION

1. Parts identified by the \triangle symbol on the schematic diagram and the parts list are critical for safety. Use only replacement parts that have critical characteristics recommended by the manufacturer.
2. Make leakage-current or resistance measurements to determine that exposed parts are acceptably insulated from the supply circuit before returning the appliance to the customer.

•SPECIFICATIONS

<AU-X201i>

Power output

30 watts per channel into 1 kHz, 8 ohms.

DIN

60 watts per channel into 4 ohms.

Load impedance..... 4 to 16 ohms

Total harmonic distortion less than 0.05% at or below rated min. RMS, both channels driven, from 20 to 20,000 Hz.

Intermodulation distortion

(60 Hz: 7 kHz=4:1 SMPTE method)

..... less than 0.05% at rated power output

Frequency response (at 1 watt)

Overall (from CD)..... 1 to 100,000 Hz, +0 dB -3 dB

RIAA curve deviation (PHONO, 20 Hz to 20 kHz)

..... +0.5 dB, -0.5 dB

Input sensitivity and impedance (at 1 kHz)

PHONO (MM)..... 3.5 mV/47 kohms
(Max. input capability: 150 mV at 1 kHz, less than 0.1% total harmonic distortion)

CD, TUNER, LINE..... 200 mV/47 kohms

TAPE PLAY-1, 2 200 mV/47 kohms

Output level (at 1 kHz)

TAPE REC-1, 2 200 mV into 47 kohms

Signal to noise ratio (short-circuit, A-network)

PHONO (MM)..... 75 dB

CD, TUNER, LINE..... 105 dB

TAPE PLAY-1, 2 105 dB

Controls and Filter

BASS ± 8 dB at 50 Hz

TREBLE..... ± 8 dB at 10 kHz

SUBSONIC -3 dB at 16 Hz (6 dB/oct)

LOUDNESS +8 dB at 50 Hz

(VOLUME: -30 dB

position) +4 dB at 10 kHz

Power requirements AC 120V/220V/240V, 50/60 Hz

For U.S.A. & Canada .. AC 120V, 60 Hz

Power consumption 200 watts

Dimensions 430 mm (16-15/16") W

136 mm (5-3/8") H

311 mm (12-1/4") D

Weight 7.0 kg (15.4 lbs) net

9.0 kg (19.8 lbs) packed

Design and specifications subject to changes without notice for improvements.

Due to local laws and regulations, this unit sold in some areas are not equipped with variable voltage selectors.

•SPECIFICATIONS

<AU-X301i>

Power output

Min. RMS, both channels driven, from 20 to 20,000 Hz, with no more than 0.05% total harmonic distortion.
65 watts per channel into 8 ohms.

DIN

100 watts per channel into 4 ohms.

Load impedance..... 4 to 16 ohms

Total harmonic distortion less than 0.05% at or below rated min. RMS power output

Intermodulation distortion

(60 Hz: 7 kHz=4:1 SMPTE method)
..... less than 0.05% at rated power output

Frequency response (at 1 watt)

Overall (from CD)..... 1 to 150,000 Hz, +0 dB -3 dB

RIAA curve deviation (PHONO-MM, 20 Hz to 20 kHz)

..... +0.5 dB, -0.5 dB

Input sensitivity and impedance (at 1 kHz)

PHONO (MC)..... 420 μ V/100 or 22 ohms
PHONO (MM)..... 3.5 mV/47 kohms
(Max. input capability: 150 mV at 1 kHz, less than 0.1% total harmonic distortion)

CD, TUNER, LINE..... 200 mV/47 kohms

TAPE PLAY-1, 2..... 200 mV/47 kohms

Output level (at 1 kHz)

TAPE REC-1, 2..... 200 mV into 47 kohms

Signal to noise ratio (short-circuit, A-network)

PHONO (MC)..... 65 dB
PHONO (MM)..... 80 dB
CD, TUNER, LINE..... 105 dB
TAPE PLAY-1, 2..... 105 dB

Controls and Filter

BASS \pm 8 dB at 50 Hz
TREBLE..... \pm 8 dB at 10 kHz
SUBSONIC -3 dB at 16 Hz (6 dB/oct)
LOUDNESS +8 dB at 50 Hz
(VOLUME: -30 dB position)

Power requirements +4 dB at 10 kHz
AC 120V/220V/240V, 50/60 Hz

For U.S.A. & Canada .. AC 120V, 60 Hz

Power consumption 330 watts 410 VA Rated
460 watts Maximum

Dimensions 430 mm (16-15/16") W
136 mm (5-3/8") H
311 mm (12-1/4") D

Weight 9.5 kg (20.9 lbs) net
11.0 kg (24.3 lbs) packed

- * Design and specifications subject to changes without notice for improvements.
- * Due to local laws and regulations, this unit sold in some areas are not equipped with variable voltage selectors.

NOTE

1. The symbols, EU, EG, SEV, SS and XX <EXPORT> on the parts list and the schematic diagram mean followings respectively.

- EU Manufactured for European market.
- EG Manufactured for F.R. Germany market.
- SEV Manufactured for Swiss Market.
- SS..... Manufactured for Saudi Arabia Market.
- XX <EXPORT> Standard Version.
- NON MARK Common Parts.

2. Some printed circuit boards are not supplied assembled. To separate these in this service manual, the stock numbers are not indicated for these boards. However, stock numbers for individual parts are indicated.

3. Since some capacitors and resistors are omitted from parts lists in this service manual, refer to the Common Parts List for capacitors and resistors, which was issued on March 1987.

4. Abbreviations in this service manual are as follows.

•Abbreviations List

C.R. : Carbon Resistor	E.B.L. : Low Leak Bi-Polar Electrolytic Capacitor
S.R. : Solid Resistor	Ta.C. : Tantalum Capacitor
Ce.R. : Cement Resistor	F.C. : Film Capacitor
M.R. : Metal Film Resistor	M.P. : Metalized Paper Capacitor
F.R. : Fusing Resistor	P.C. : Polystyrene Capacitor
N.I.R. : Non-Inflammable Resistor	M.M.C. : Metalized Mylar Capacitor
A.R. : Array Resistor	A.C. : Array Capacitor
C.C. : Ceramic Capacitor	V.R. : Variable Resistor
C.T. : Ceramic Capacitor, Temperature Compensation	S.V.R. : Semi Variable Resistor
E.C. : Electrolytic Capacitor	SW. : Switch
E.L. : Low Leak Electrolytic Capacitor	Chip R. : Chip Resistor
E.B. : Bi-Polar Electrolytic Capacitor	Chip C. : Chip Capacitor

1. BLOCK DIAGRAM

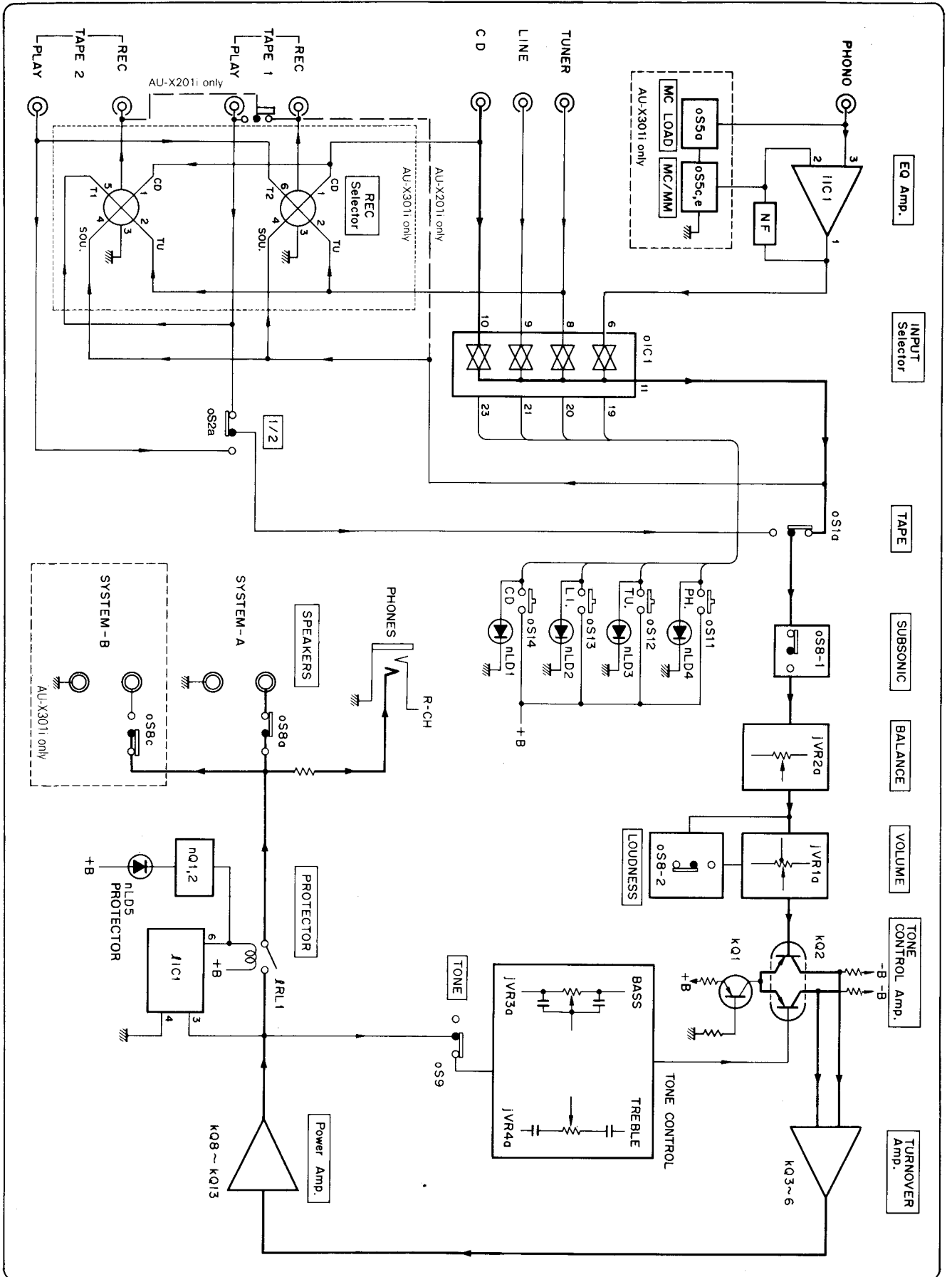

2. ELECTRIC PARTS LIST OF BOARD

2-1. F-5716 Tone Control V.R. Board

<Stock No. 01049601 = AU-X201i/01048501 = AU-X301i>

Parts No.	Stock No.	Description
jC1	48103000	0.22 μ F 50V E.B.
jC5	48103000	0.22 μ F 50V E.B.
jVR1	83005400	150k Ω (B) V.R., VOLUME
jVR2	83003200	250KMN V.R., BALANCE
jVR3	83003100	50k Ω (C) V.R., BASS
jVR4	83003100	50k Ω (C) V.R., TREBLE
nLD1	48849300	SEL3913K, CD
nLD2	48849300	SEL3913K, LINE
nLD3	48849300	SEL3913K, TUNER
nLD4	48849300	SEL3913K, PHONO
oS1	48837500	Push SW., TAPE
oS2	48837500	Push SW., 1/2 (AU-X301i)
	48837300	Push SW., 1/2 (AU-X201i)
oS8	83032000	Push SW., SUBSONIC-LOUDNESS
oS9	83002800	Push SW., TONE

2-2. F-5718 PROTECTOR Ind. Board

Parts No.	Stock No.	Description
nLD5	48866300	AY2222S

2-3. F-5719 PHONES Jack Board

Parts No.	Stock No.	Description
oJ1	83002600	Jack

2-4. F-5720 SPEAKERS Switch Board

Parts No.	Stock No.	Description
Δ kR35	46624700	220 Ω 2W N.I.R. (AU-X301i)
Δ	46249700	220 Ω 1W N.I.R. (AU-X201i)
oS7	83032900	Push SW., SPEAKERS (AU-X301i)
	83032800	Push SW., SPEAKERS (AU-X201i)

2-5. F-5721 SPEAKERS Terminal Board (AU-X301i)

Parts No.	Stock No.	Description
oZ4	48569100	8P Terminal, Speaker

2-6. F-5723 SPEAKERS Terminal Board (AU-X201i)

Parts No.	Stock No.	Description
oZ4	48699700	4P Terminal, Speaker

2-7. F-5717 Power Amp. Board

<Stock No. 01049701 = AU-X201i/01048601 = AU-X301i>

Parts No.	Stock No.	Description
•Transistor		
kQ1	07299601	2SA1115
	or 46392201	2SA1175
kQ2	48577701	2SA1349
kQ3	46728301	2SC2705
	or 48113001	2SC2229
kQ4	46728301	2SC2705
	or 48113001	2SC2229
kQ5	03064001	2SC1904
	or 46128101	2SC2911
kQ6	03007901	2SA899
	or 46128001	2SA1209
Δ kQ7	03067401	2SC1845
kQ8	48061801	2SC3244
kQ9	48064001	2SA1284
kQ10	46728901	2SC3298 (AU-X301i)
	or 48158701	2SC2591 (AU-X301i)
	07206401	2SD600K (AU-X201i)
kQ11	46728801	2SA1306 (AU-X301i)
	or 48158601	2SA1111 (AU-X301i)
	07206301	2SB631K (AU-X201i)
Δ kQ12	48844201	2SC3856 (AU-X301i)
Δ	48844401	2SC3854 (AU-X201i)
Δ kQ13	48844101	2SA1492 (AU-X301i)
Δ	48844301	2SA1490 (AU-X201i)
•Diode		
kD1	83000100	1N4148
Δ kR13	46230200	1k Ω 1/2W N.I.R. (AU-X301i)
Δ	46229800	470 Ω 1/2W N.I.R. (AU-X201i)
Δ kR14	46229100	120 Ω 1/2W N.I.R. (AU-X301i)
Δ	46228700	56 Ω 1/2W N.I.R. (AU-X201i)
Δ kR15	46230200	1k Ω 1/2W N.I.R. (AU-X301i)
Δ	46229800	470 Ω 1/2W N.I.R. (AU-X201i)
Δ kR16	46230200	1k Ω 1/2W N.I.R. (AU-X301i)
Δ	46229800	470 Ω 1/2W N.I.R. (AU-X201i)
Δ kR17	46230200	1k Ω 1/2W N.I.R. (AU-X301i)
Δ	46229800	470 Ω 1/2W N.I.R. (AU-X201i)
Δ kR18	46229100	120 Ω 1/2W N.I.R. (AU-X301i)
Δ	46228700	56 Ω 1/2W N.I.R. (AU-X201i)
Δ kR22	46228200	33 Ω 1/2W N.I.R.
Δ kR23	46228200	33 Ω 1/2W N.I.R.
Δ kR28	46230200	1k Ω 1/2W N.I.R.
Δ kR29	46229100	120 Ω 1/2W N.I.R.
Δ kR30	46227400	4.7 Ω 1/2W N.I.R.
Δ kR31	46227400	4.7 Ω 1/2W N.I.R.
Δ kR32	83013200	0.22 Ω 5W Ce.R.
Δ kR33	46623100	10 Ω 2W N.I.R. (AU-X301i)
Δ	46248100	10 Ω 1W N.I.R. (AU-X201i)
Δ kR34	46247300	2.2 Ω 1W N.I.R. (AU-X301i)
Δ	46227000	2.2 Ω 1/2W N.I.R. (AU-X201i)
Δ kR38	83013200	0.22 Ω 5W Ce.R.
KL1	83020100	Inductor 0.8 μ H
kVR1	83006900	1k Ω S.V.R., Bias
•Transistor		
IQ1	46581701	2SC1845 (AU-X301i)
IQ2	46581601	2SA992 (AU-X301i)
•IC		
Δ IIC1	46207600	TA7317P
•Diode		
ID1	83000100	1N4148 (AU-X301i)
ID2	83000100	1N4148 (AU-X301i)
ID3	83024700	1N4003

Parts List <F-5717>

Parts No.	Stock No.	Description
ID4	83024700	1N4003
ID5	83005000	1N4002
△IR18	46229900	560Ω 1/2W N.I.R. (AU-X301i)
△	46229500	270Ω 1/2W N.I.R. (AU-X201i)
IC5	48104200	220μF 6.3V E.B.
IRL1	46254900	Relay, AP24D2
•Transistor		
nQ1	03067401	2SC1845
nQ2	03067401	2SC1845
•Diode		
nD1	83000100	1N4148

2-8. F-5722 Power Supply Board

< Stock No. 01050201 = AU-X201i/01049101 = AU-X301i >

Parts No.	Stock No.	Description
•Transistor		
△mQ1	48061801	2SC3244 (AU-X301i)
△mQ2	48064001	2SA1284 (AU-X301i)
•Diode		
△mD1	83002000	KBU6D (AU-X301i)
△	83002100	KBU4D (AU-X201i)
△mD2	83020200	DF04M
•Zener Diode		
mDZ1	46114400	05Z15-X
or	46114500	05Z15-Y
or	46114600	05Z15-Z
or	46828000	RD15E-B1
or	46828100	RD15E-B2
or	03170800	RD15F (AU-X201i)
mDZ2	46114400	05Z15-X
or	46114500	05Z15-Y
or	46114600	05Z15-Z
or	46828000	RD15E-B1
or	46828100	RD15E-B2
or	03170800	RD15F (AU-X201i)
△mR12	46623100	10Ω 2W N.I.R.
mC1	48913300	8200μF 63V E.C. (AU-X301i)
	48913400	6800μF 42V E.C. (AU-X201i)
mC2	48913300	8200μF 63V E.C. (AU-X301i)
	48913400	6800μF 42V E.C. (AU-X201i)
mC11	08680400	0.01μF 500V C.C.
mC12	08680400	0.01μF 500V C.C.
△pC1	46425800	0.01μF 400V C.C.
△	or 46943200	0.01μF 400V C.C.
△pF1	83021900	Fuse 3A for AU-X301i (XX-SS)
△	83021600	Fuse 1.5A for AU-X201i (SS)
△	83024000	Fuse 3.15A for AU-X301i (EU-EG-SEV)
△	83023600	Fuse 1.25A for AU-X201i (EU-EG-SEV)
△pF2	83021900	Fuse 3A for AU-X301i (XX-SS)
△	83021600	Fuse 1.5A for AU-X201i (SS)
△	83023100	Fuse 400mA (SEV)
△pS1	48844500	Push SW., POWER

2-9. F-5751 EQ Amp. INPUT Terminal Board

< Stock No. 01050401 = AU-X201i/01049301 = AU-X301i >

Parts No.	Stock No.	Description
•IC		
iIC1	46288800	M5220L (AU-X301i)
	46147700	M5218L (AU-X201i)
oIC1	48570700	TC9152P
•Zener Diode		
oDZ1	46109000	05Z2.7-X
or	46109100	05Z2.7-Y
or	46109200	05Z2.7-Z
or	46823000	RD2.7E-B1
or	46823100	RD2.7E-B2
oL1	83030300	170μH Indicator
oS3	07200200	Slide SW., REC SELECTOR (AU-X301i)
oS5	83032100	Push SW., MM/MC•MC LOAD (AU-X301i)
oZ1	48528400	2P Terminal, PHONO
oZ3	48528600	6P Terminal, TUNER•LINE•CD

2-10. F-5753 Selector Switch Board

Parts No.	Stock No.	Description
oS11	83003000	Push SW., PHONO
oS12	83003000	Push SW., TUNER
oS13	83003000	Push SW., LINE
oS14	83003000	Push SW., CD

2-11. F-5752 TAPE/DAT Terminal Board

Parts No.	Stock No.	Description
oZ2	48528500	4P Terminal, TAPE/DAT

3. PARTS LOCATION OF CIRCUIT BOARD

3-1. F-5717 Power Amp. Board

Component Side

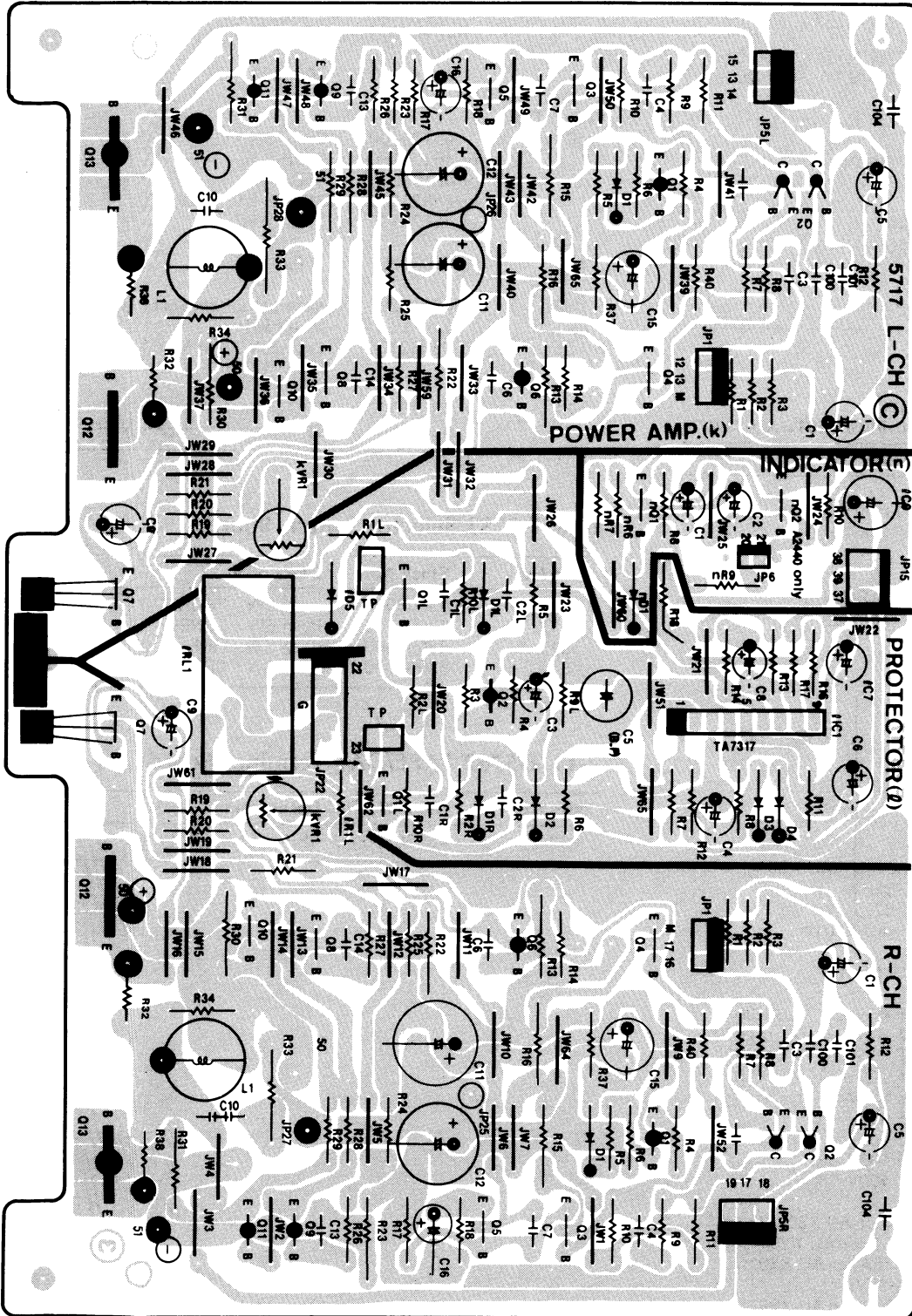

3-2. F-5721 SPEAKERS Terminal Board

Component Side (AU-X301i)

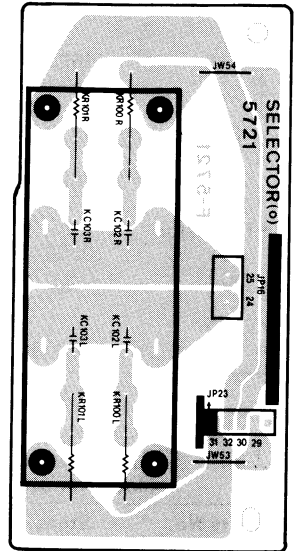

3-3. F-5753 Selector Switch Board

Component Side

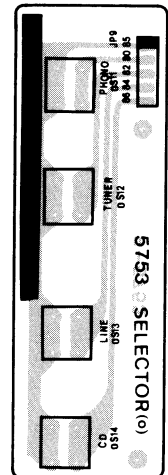

3-4. F-5719 PHONES Jack Board

Component Side

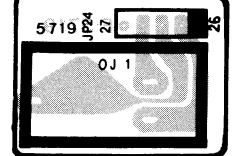

3-5. F-5718 PROTECTOR Ind. Board

Component Side

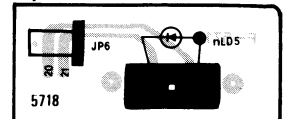

3-6. F-5751 EQ Amp. & INPUT Terminal Board

Component Side

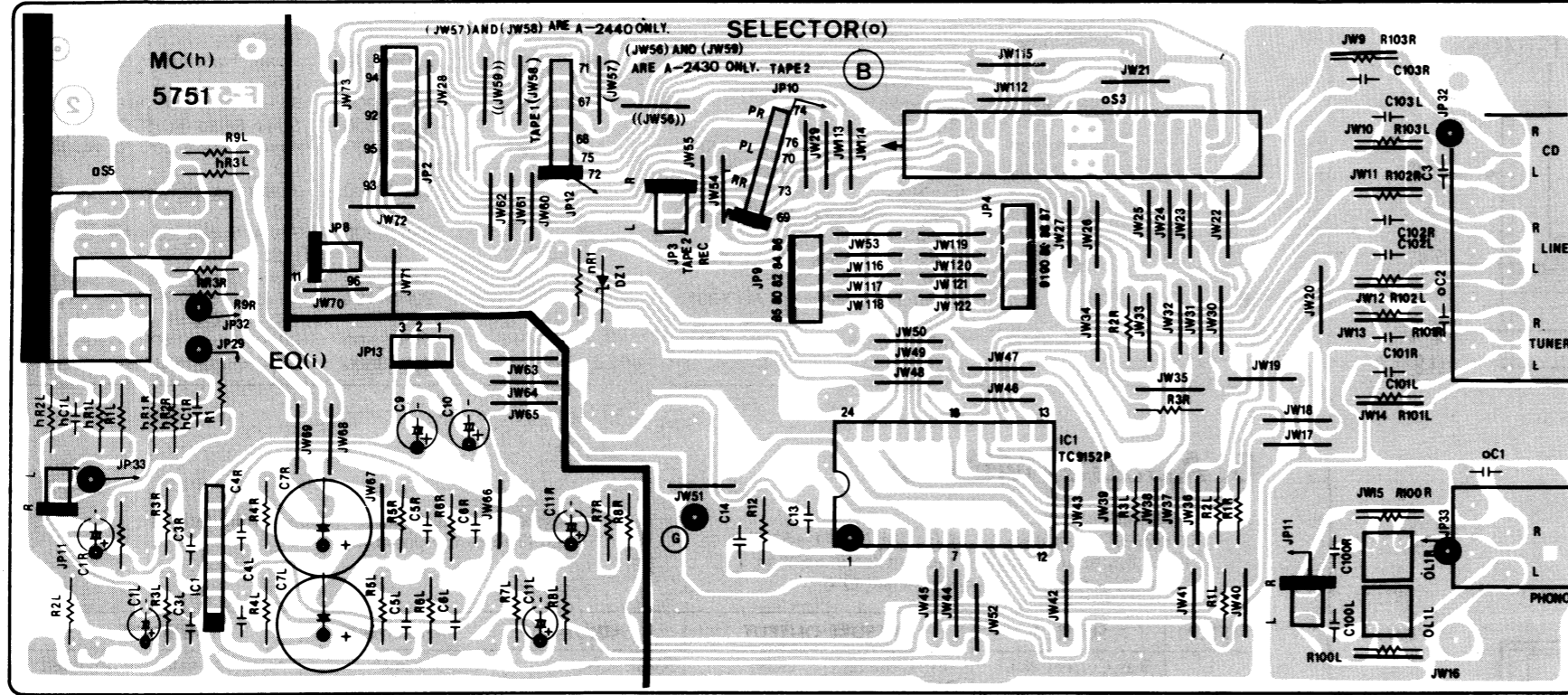

3-8. F-5752 TAPE/DAT

Component Side Terminal Board

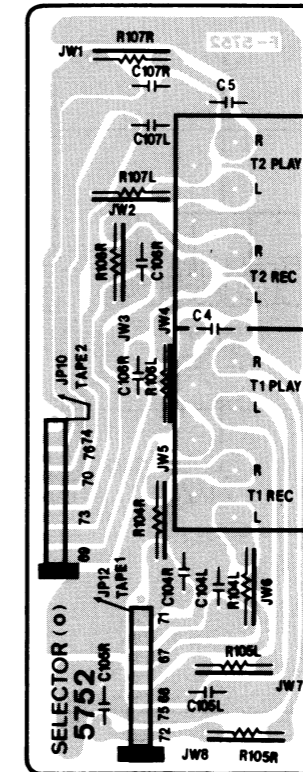

3-9. F-5722 Power Supply Board

Component Side

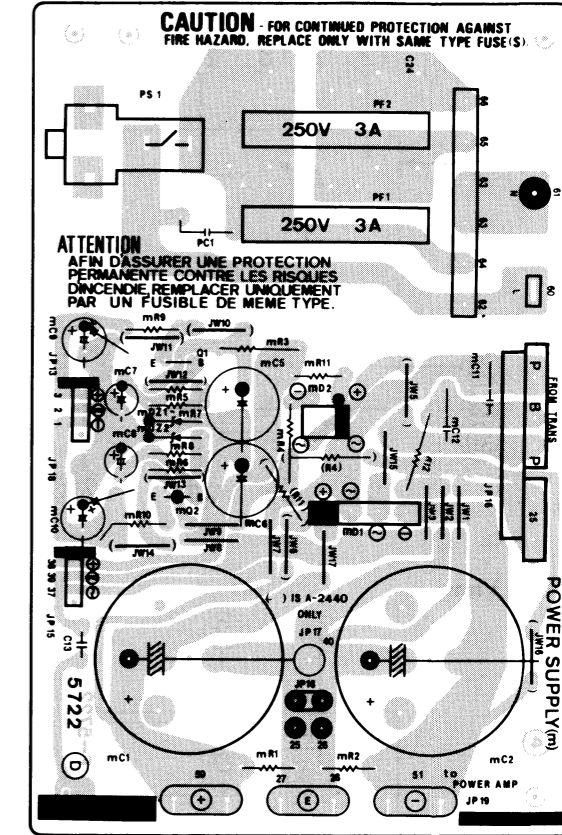

3-7. F-5716 Tone Control Volume Board

Component Side

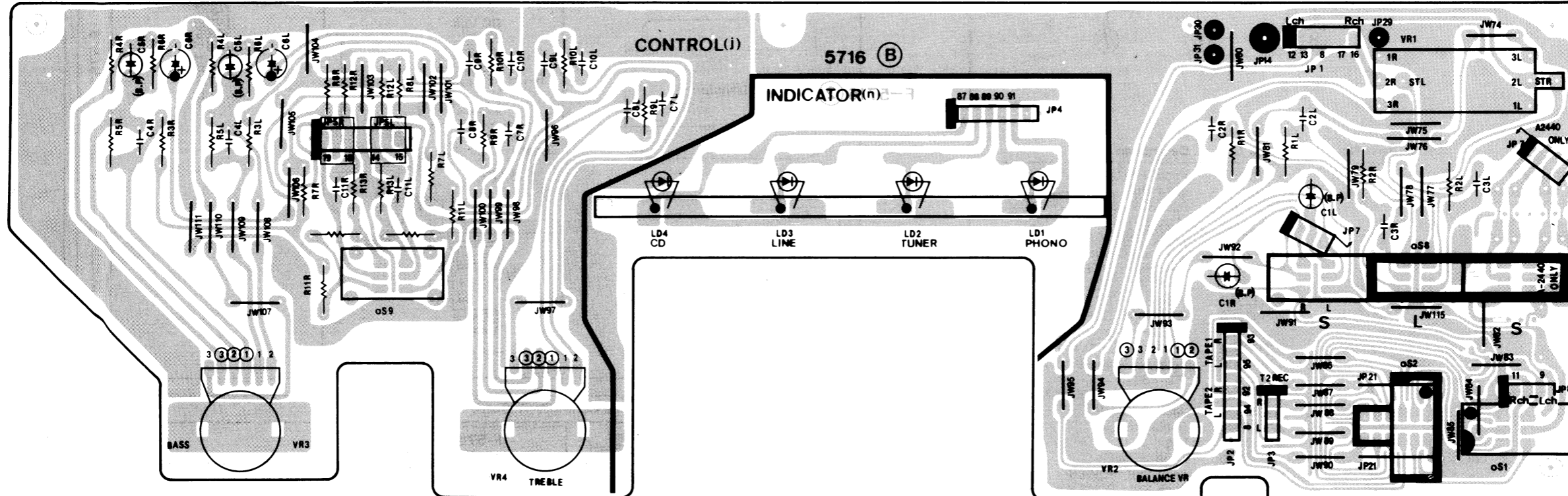

3-10. F-5720 SPEAKERS

Component Side Switch Board

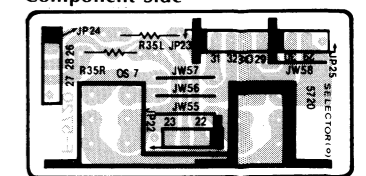

3-11. F-5723 SPEAKERS

Component Side Terminal Board (AU-X201i)

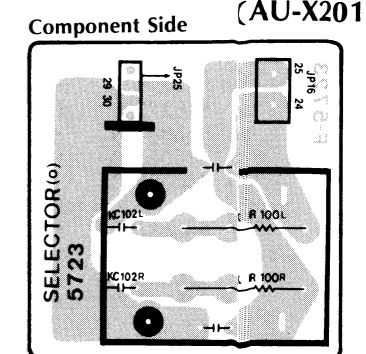

4. OTHER PARTS

• Front View

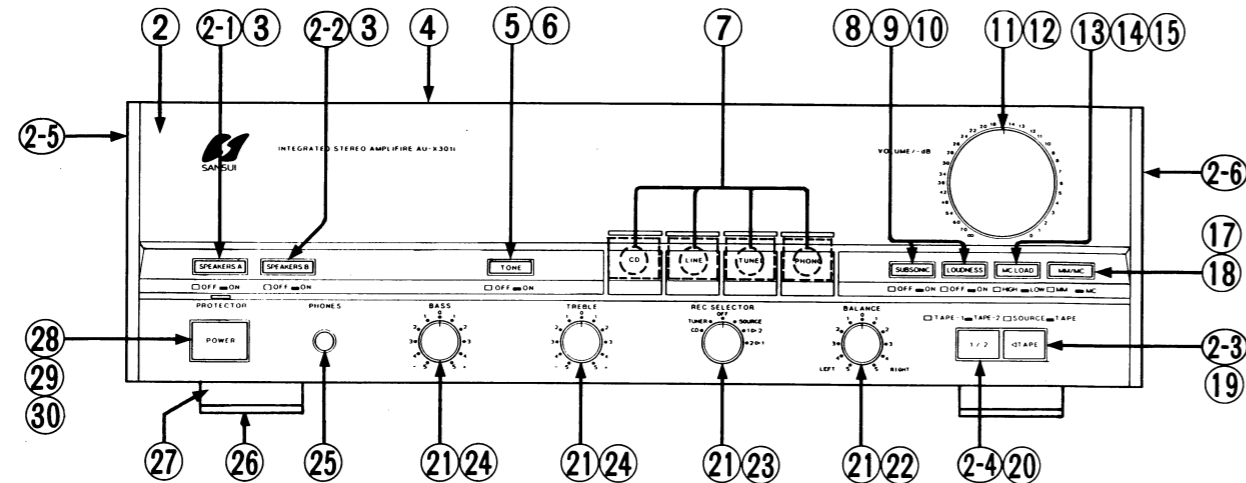

• Rear View

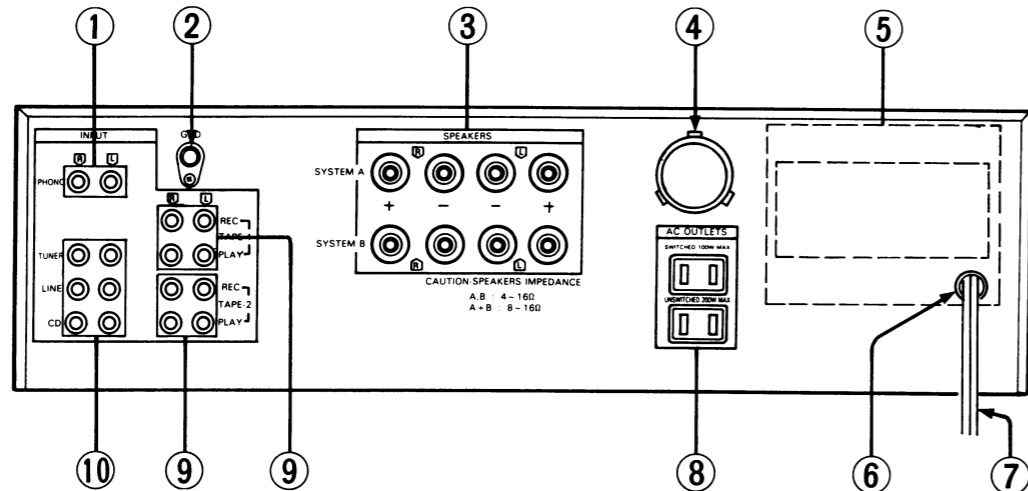

Parts List < Front View >

Parts No.	Stock No.	Description	Parts No.	Stock No.	Description
2	37503801	Front Panel Ass'y (AU-X301i)	13	84583400	Knob, MC LOAD (AU-X301i)
	37503701	Front Panel Ass'y (AU-X201i)	14	84526900	Joint Shaft, MC LOAD (AU-X301i)
2-1	84583600	Knob, SPEAKERS-A (AU-X301i)	15	83032100	Push SW., MC LOAD-MM/MC (AU-X301i)
	84583800	Knob, SPEAKERS (AU-X201i)	17	84583500	Knob, MM/MC (AU-X301i)
2-2	84583700	Knob, SPEAKERS-B (AU-X301i)	18	84527000	Joint Shaft, MM/MC (AU-X301i)
2-3	84514410	Knob, TAPE	19	48837500	Push SW., TAPE
2-4	84526100	Knob, 1/2	20	48837500	Push SW., 1/2 (AU-X301i)
2-5	84582600	Left Side Panel	21	48837300	Push SW., 1/2 (AU-X201i)
2-6	84582500	Right Side Panel	22	83003200	Knob, BALANCE-REC SELECTOR-TABLE-BASS
3	83032900	Push SW., SPEAKERS (AU-X301i)	23	48837000	Rotary Selector with Flexible wire (AU-X301i)
	83032800	Push SW., SPEAKERS (AU-X201i)	24	83003100	50kΩ V.R., TREBLE-BASS
4	84527200	Bonnet	25	83002600	Jack, PHONES
5	84583100	Knob, TONE	26	27593800	Rubber for Leg
6	83002800	Push SW., TONE	27	84586400	Leg
7	83003000	Tact SW., PHONO-TUNER-LINE-CD	28	84594300	Knob, POWER
8	84583200	Knob, LOUDNESS	29	84526800	Joint Shft, POWER
9	84583300	Knob, SUBSONIC	△ 30	48844500	Push SW., POWER
10	83032000	Push SW., LOUDNESS-SUBSONIC			
11	84582900	Knob, VOLUME			
12	83005400	150kΩ V.R., VOLUME			

Parts List < Rear View >

Parts No.	Stock No.	Description	Parts No.	Stock No.	Description
1	48528400	2P Terminal, PHONO	△	83048505	Power Transformer for AU-X201i (EU-SEV)
2	84528300	Ground Terminal	△	83048508	Power Transformer for AU-X201i (EG)
3	48569100	8P Terminal, SPEAKERS (AU-X301i)	6	39104900	Strain Relief (XX=AU-X301i only)
	48699700	4P Terminal, SPEAKERS (AU-X201i)		48913500	Strain Relief (EU-SS-EG-SEV)
△ 4	84175200	Plug, Voltage Selector (XX-SS)	△ 7	83003500	Power Supply Cord for AU-X301i (XX)
△	07204700	Slide SW., Voltage Selector (EU-SEV)	△	83034900	Power Supply Cord for AU-X201i (SS)
△ 5	83001519	Power Transformer for AU-X301i (XX-SS)	△	83034900	Power Supply Cord for AU-X301i (SS)
△	83001508	Power Transformer for AU-X301i (EG)	△	83000600	Power Supply Cord (EU-SEV-EG)
△	83001515	Power Transformer for AU-X301i (EU-SEV)	△ 8	83004100	AC OUTLET (XX-SS=AU-X301i/SS=AU-X201i)
△	83048509	Power Transformer for AU-X201i (SS)	9	48528500	4P Terminal, TAPE-1-TAPE-2
			10	48528600	6P Terminal, TUNER-LINE-CD

5. ADJUSTMENTS

- Note: 1) Master Volume Minimum
 2) Room Temperature 18°C ~ 28°C (65°F ~ 83°F)
 3) For this adjustment, run the unit for more than 5 minutes after the power is switched ON.

- 4) Before turning ON power switch, set the kVR1 on F-5717 to center position.

STEP	SUBJECT	MEASURE OUTPUT	ADJUST	ADJUST FOR	REMARKS
1.	Bias Current Adj. <L-ch>	Test Terminal (TP, L-ch), DC Volt Meter	kVR1 <L-ch>	DC 5 ± 2mV	•This bias value is converted from current value to voltage by ohms law.
2.	Bias Current Adj. <R-ch>	Test Terminal (TP, R-ch), DC Volt Meter	kVR1 <R-ch>	DC 5 ± 2mV	

Fig. 5-1 Printed Circuit Location and adjustment points.

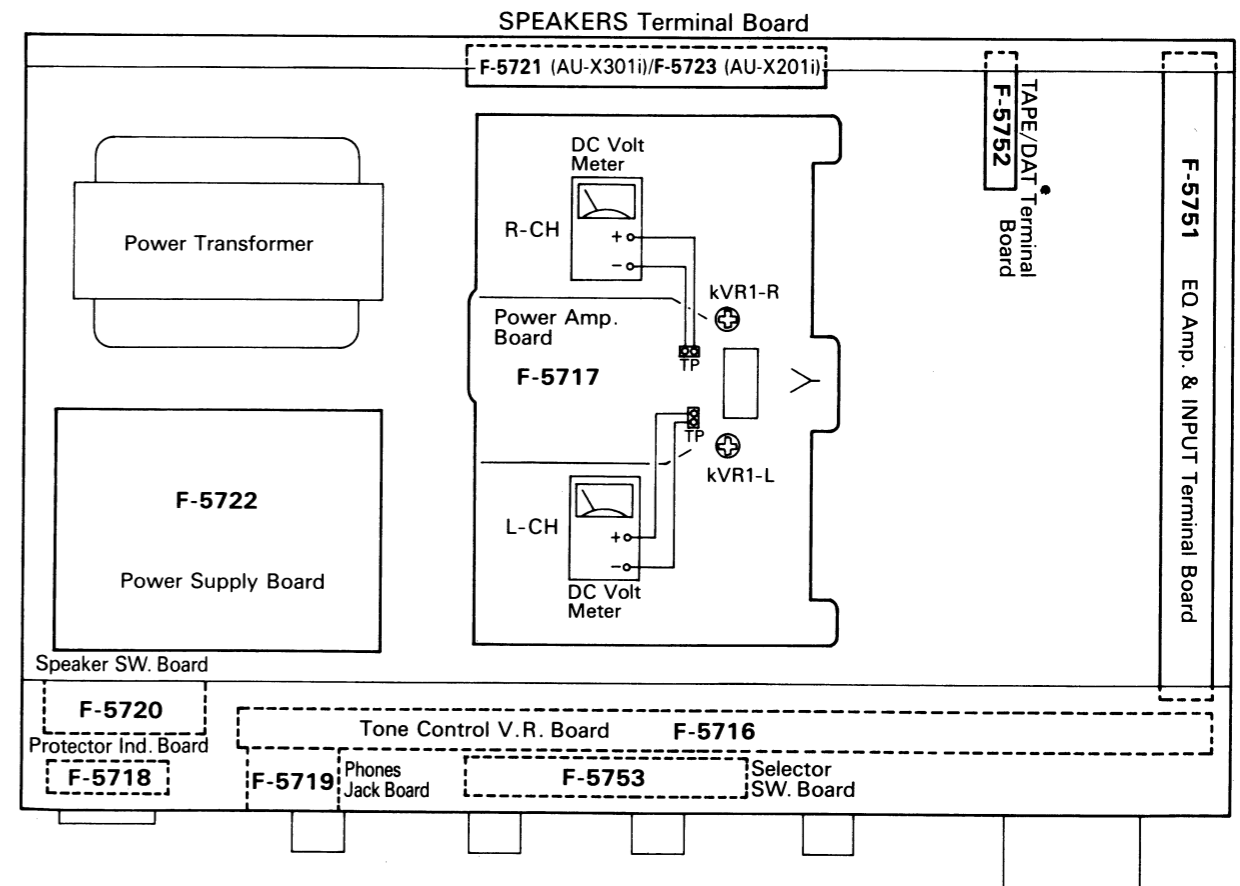

6. SCHEMATIC DIAGRAM 6-1. AU-X201i Main Section

• Design and specifications subject to change without notice for improvement.
 • La présentation et les spécifications sont susceptibles d'être modifiées sans préavis par suites d'améliorations éventuelles.
 • Änderungen, die dem technischen Fortschritt dienen, bleiben vorbehalten.

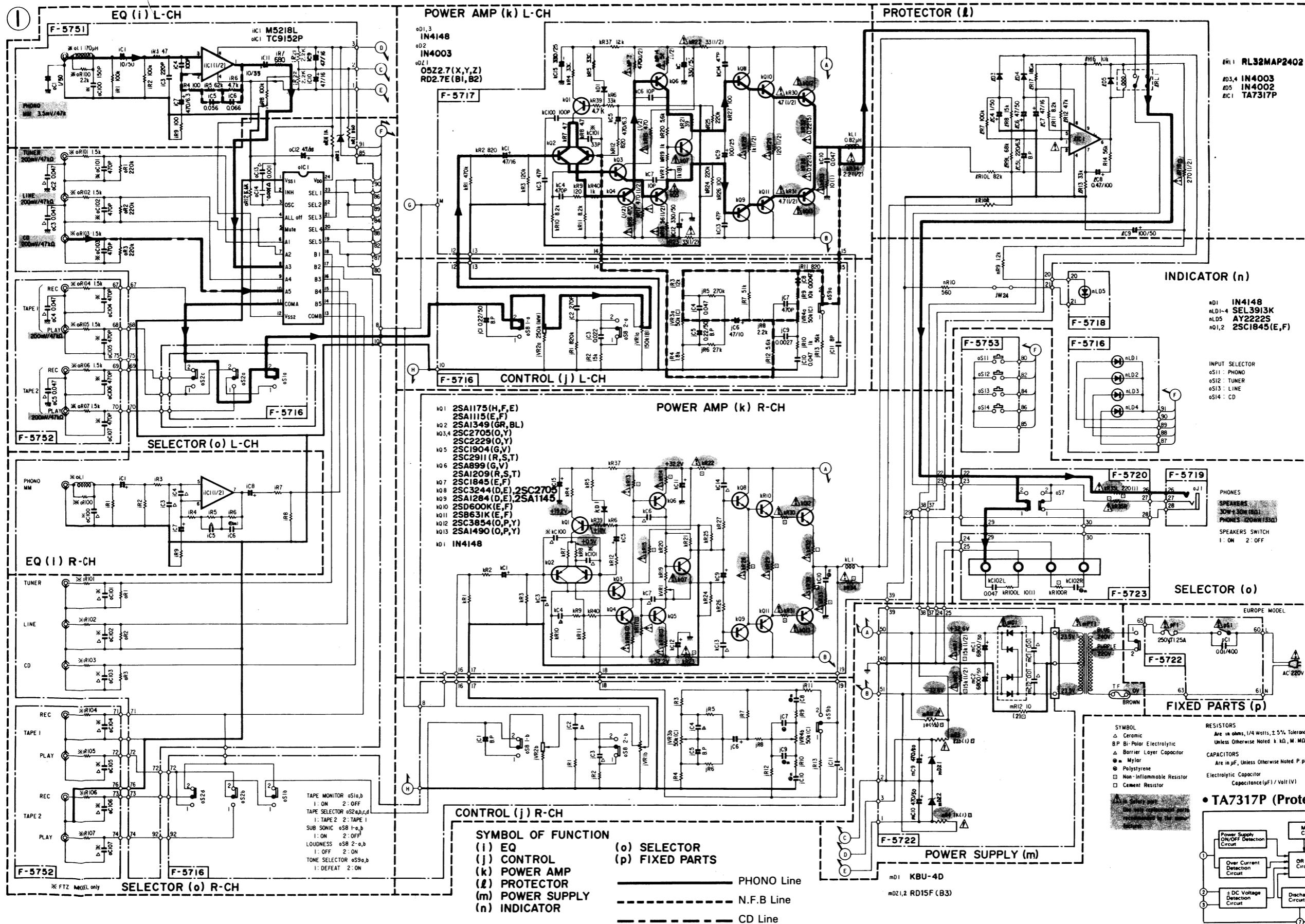

- 2SA992
- 2SA1284
- 2SC1845
- 2SC2229
- 2SC2705
- 2SC3244
- 2SA1306
- 2SC2591
- 2SA899
- 2SA1309
- 2SB631
- 2SC1904
- 2SC2911
- 2SD600
- 2SA1115
- 2SA1175
- 2SA1490
- 2SA1492
- 2SC3854
- 2SC3856
- 2SA1349
- TA7317P
- M5220L
- TC9152P
Set or Slot or Link
- DF04M
- 11-4002
- 11-4003
- 11-4148
- KBU4D
- KBU6D
- 0.5:2.7
- 0.5:1.5
- RD2.7E
- RD1.5E

1
2
3
4
5

6-2. AU-X301i Main Section

* Design and specifications subject to change without notice for improvement.
 * La présentation et les spécifications sont susceptibles d'être modifiées sans préavis par suites d'améliorations éventuelles.
 * Änderungen, die dem technischen Fortschritt dienen, bleiben vorbehalten.

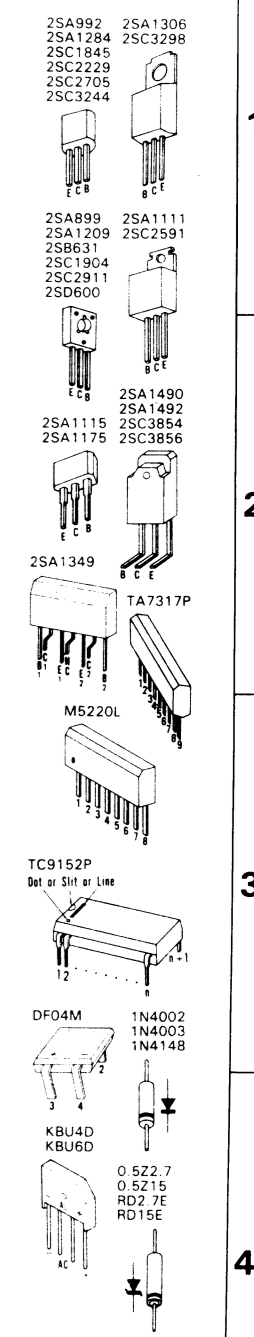
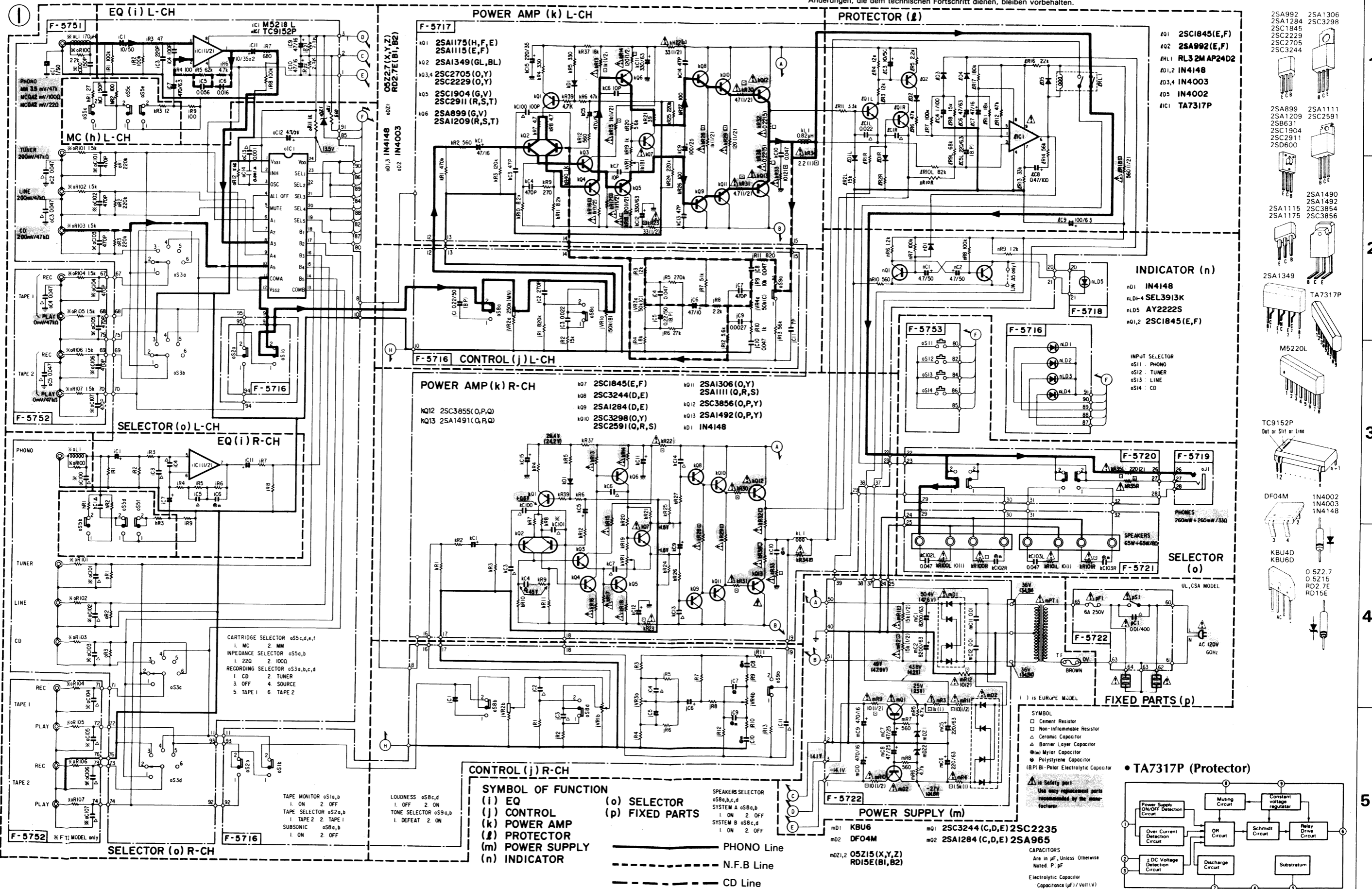

A	B	C	D
---	---	---	---

6-3. AU-X201i Power Supply (Primary-side) Section

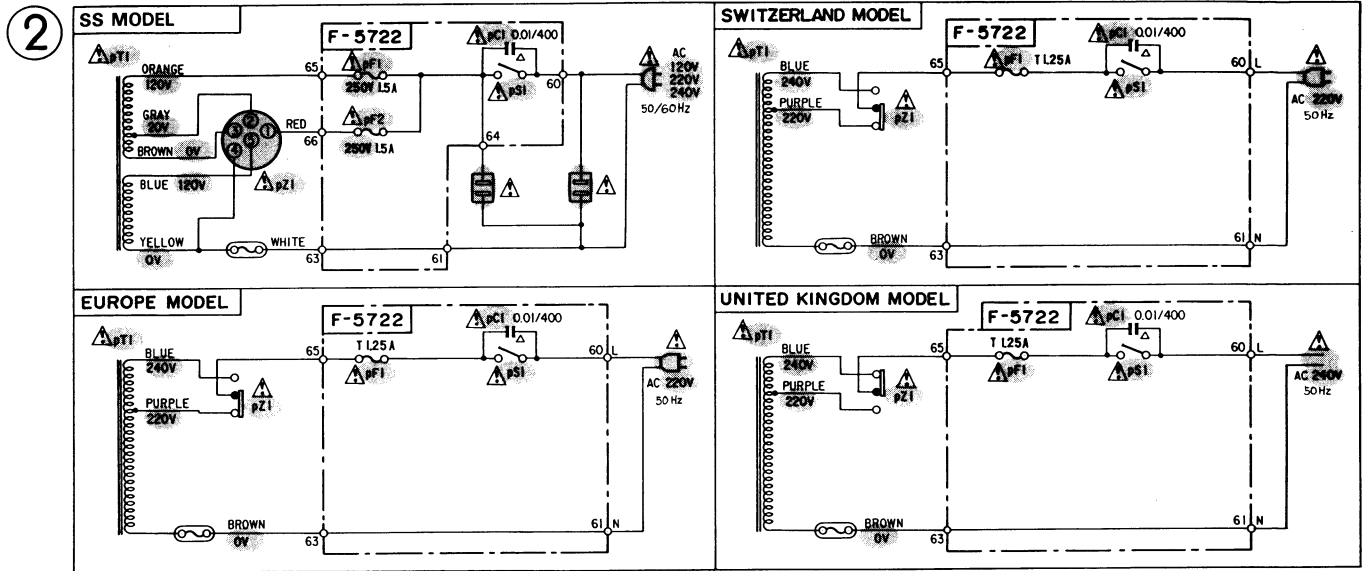

⚠ is Safety part.
Use only replacement parts
recommended by the manu-
facturer.

* Design and specifications subject to change without notice for improvement.
* La présentation et les spécifications sont susceptibles d'être modifiées sans préavis par suites d'améliorations éventuelles.
* Änderungen, die dem technischen Fortschritt dienen, bleiben vorbehalten.

6-4. AU-X301i Power Supply (Primary-side) Section

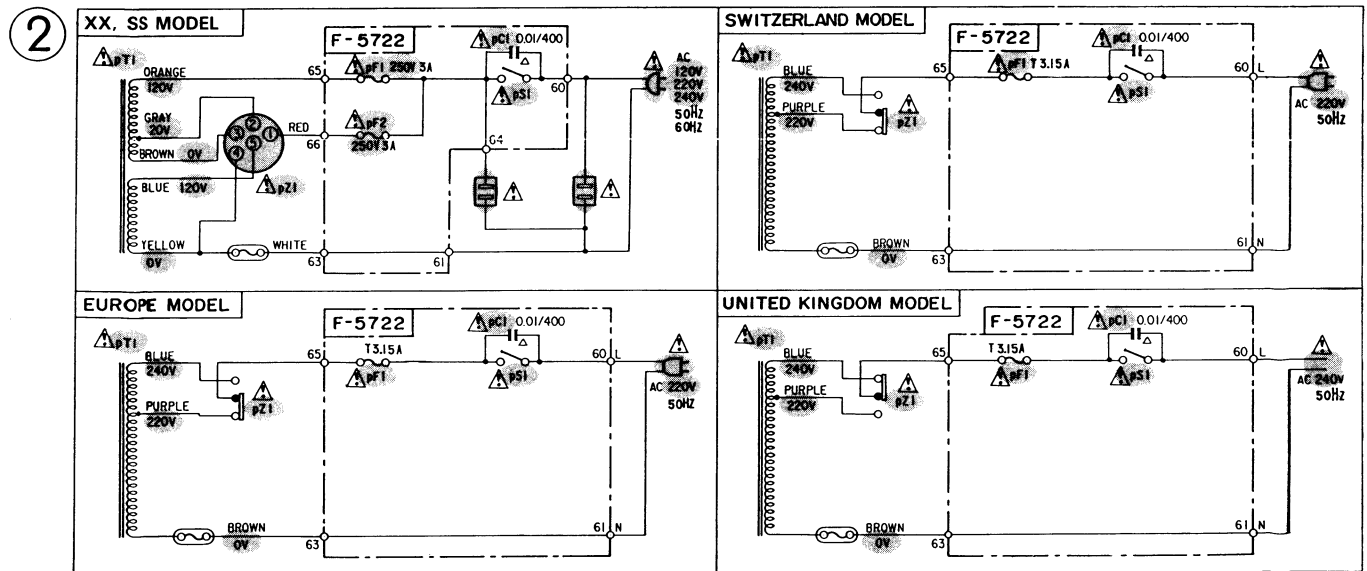

1

2

3

4

5

7. PACKING LIST

Parts No.	Stock No.	Description
1	47428000	Polythylene Sheet
2	47859600	Vinyl Bag
3	84527300	Styrofoam Packing
4	84589200	Carton Case (AU-X201i)
	84589100	Carton Case (AU-X301i)

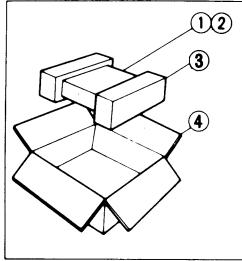

8. ACCESSORY LIST

Stock No.	Description
84454300	Operating Instruction (*E•F•S) <AU-X301i/X201i>
84454400	Operating Instruction (*G•I•Sw) <AU-X301i/X201i>

***Note:**

E•F•S: English•French and Spanish Version
G•I•Sw: German•Italian and Swedish Version



SANSUI ELECTRIC CO., LTD.:

14-1, Izumi 2-chome, Suginami-ku Tokyo 168 Japan
 PHONE: (03) 324-8891/TELEX: 232-2076 (International Division)

SANSUI ELECTRONICS CORPORATION:

1250 Valley Brook Ave. Lyndhurst, N.J. 07071 U.S.A.
 17150 South Margay Ave. Carson, California 90746 U.S.A.
 3036 Koapaka Street, Honolulu, Hawaii 96819 U.S.A.

SANSUI ELECTRONICS G.M.B.H.:

Paul Ehrlich Strasse 8, 6074 Rödermark 2, West Germany

山水電気株式会社

東京都杉並区和泉2-14-1(〒168)